

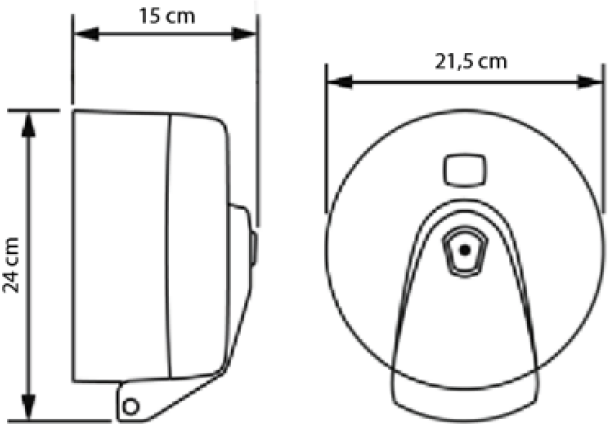



## TECHNICAL SPECIFICATIONS

APPEARANCE OF THE PRODUCT	
PHOTO	SCHEMA
	
INSTALLING PAPER & USING	
 <p>Open the lid with key.</p>	 <p>Put the paper towel in your dispenser taking the end of the paper outside from the bottom. Close the lid.</p>
	 <p>Use toilet tissues pulling.</p>
DESCRIPTIONS	
Product Code Description of Product	Minipoint Toilet Tissue Dispenser
Product Code	K3 / K3T / K3B / K3M
Color	White / Transparent / Black / Metallic
Material	ABS Plastic
Dimensions ( Height x Width x Depth in cm)	24 x 21.5 x 15 cm
TISSUE SPECIFICATIONS	
Suitable Tissue Type	Minipoint Toilet Tissue Roll
Tissue Sheet Width	10 – 11,5 cm
Tissue Roll Diameter (Ø)	16 cm
MANUFACTURER INFORMATION	
Manufacturer	Oguzhan Plasctics and Moulding Co. Ltd.
Origin	Made in Turkey

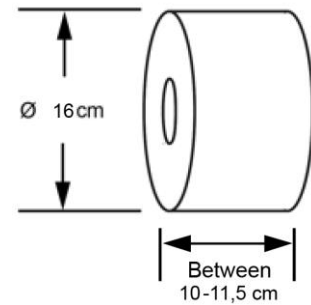

Last Update: 25.11.2020